

JOB NAME _____

Type _____

CATALOG NUMBER _____

Plugging Boxes

362 SERIES

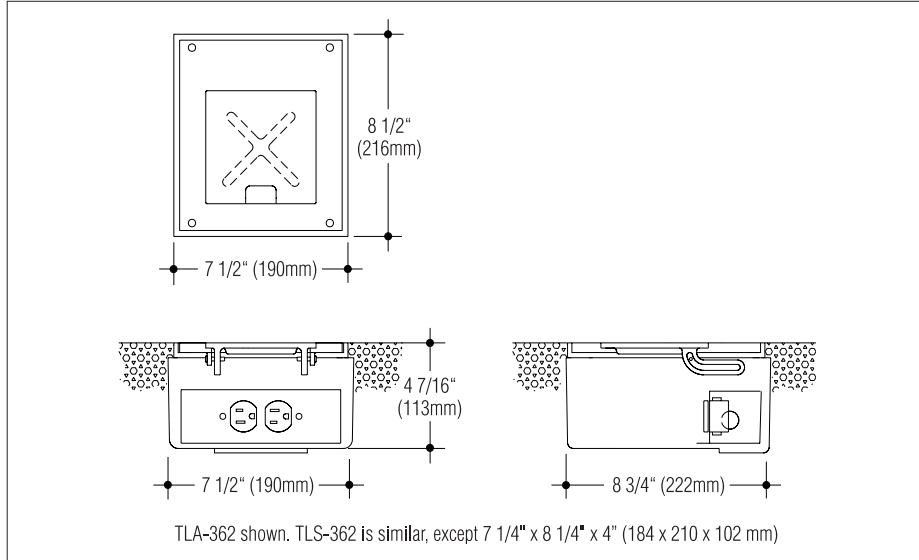

Specifications







Construction

- Cover is cast aluminum
- Standard cover door has non-skid grid and is self-closing with a cord slot
- Cover is finished with black polyester coating
- Models with Finish Trim or Carpet Flange option have smooth surface with satin aluminum finish
- TLA-362: housing and leveling collar are cast aluminum
- TLS-362: housing is 16 gauge steel

Electrical

- Various wiring devices or combinations are available as indicated with catalog suffixes
- Units with multiple-voltage devices have metal interior barrier between compartments
- TLA-362 housing has two 1/2" trade-size tapped conduit entrances
- TLS-362 housing has four 1/2"-3/4"-1" combination trade size conduit entrances
- Listed by cETLus

Catalog Numbers

Blank interior. No devices furnished	<input type="checkbox"/> TLS- / <input type="checkbox"/> TLA-362
Duplex U-ground power outlet. 15 amp, 125 volt	<input type="checkbox"/> TLS- / <input type="checkbox"/> TLA-362-1 
Duplex 3-wire twist-lock power outlet. 15 amp, 125 volt	<input type="checkbox"/> TLS- / <input type="checkbox"/> TLA-362-2 
Single 3-pole microphone outlet and single 4-pole speaker outlet. Low voltage	<input type="checkbox"/> TLS- / <input type="checkbox"/> TLA-362-3 
Single U-ground power outlet and single 3-pole microphone outlet. 15 amp, 125 volt. Low voltage	<input type="checkbox"/> TLS- / <input type="checkbox"/> TLA-362-4 
Single 3-wire twist-lock power outlet and single 3-pole microphone outlet 15 amp, 125 volt. Low voltage	<input type="checkbox"/> TLS- / <input type="checkbox"/> TLA-362-5 
Two single U-ground power outlets (NEMA 5-20) 20 amp, 125 volt	<input type="checkbox"/> TLS- / <input type="checkbox"/> TLA-362-6 
Additional combinations of above or other standards wiring devices (maximum of 2) as required. Specify complete requirements:	<input type="checkbox"/> TLS- / <input type="checkbox"/> TLA-362-9

Options

Bronze: Satin finished red brass.

Add suffix -B.

Carpet Flange: Includes Finish Trim.

Add suffix -CF.

Dust Cover Over Outlets: Add suffix -D.

Cast Iron Housing: Add suffix -FE.

Finish Trim: Add suffix -FT.

Mounting

- TLS-362: Box designed to be recessed in hardwood floors with no overlap. Particularly suitable for installation in existing floors where box flexes with floor
- TLA-362: Box designed for poured concrete floors. Frame, with leveling screws, is adjustable and is designed for dry-pack grout after cover is leveled to finished floor.

How to Specify

1. Select catalog number with desired features.
2. Add suffixes for options required to meet job conditions.



C. W. Cole & Company, Inc.
2560 N. Rosemead Boulevard
South El Monte, CA 91733-1593

Fax (626) 443-9253

Tel. (626) 443-2473

info@colelighting.com

www.colelighting.com