

JOB NAME _____

CATALOG NUMBER _____

Type _____

Steplites

L600 SERIES

SPECIFICATIONS

Construction

- Recessed housing is constructed from 16 gauge electro-galvanized steel, matte black powder-coated
- Surface housing is constructed from 16 gauge satin finished stainless steel or .063" metallic silver powder-coated aluminum
- Faceplates are 3/16" metallic silver powder-coated aluminum or satin finished stainless steel, passivated for maximum rust resistance
- Fixtures are furnished with stainless steel socket head tamperproof screws
- Diffuser is clear tempered glass, set in silicone sealant
- Internal baffle is coated matte black to eliminate glare
- Optional junction box is cast aluminum with polyester coating
- cETLus listed installation in any wall construction and suitable for wet locations in any wall construction.

Electrical

- Fixture is wired with high performance LEDs positioned for 5°, 10° or 15° cutoff (5° standard)
- Integral driver is universal voltage
- Recessed housing provided with 1/2" conduit knockout on each side, suitable for 4 wire thru-wiring, 2 in 2 out. Surface housing conduit entries located per specification
- Optional junction box allows 8 wire thru-wiring, 4 in 4 out. Provided with two 1/2" tapped conduit entrances in the bottom and one 1/2" tapped conduit entrance in each side.

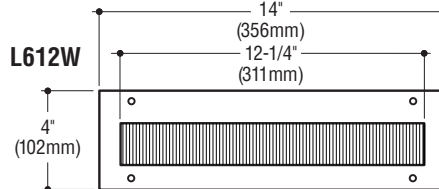
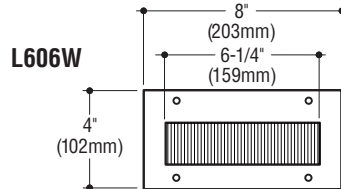
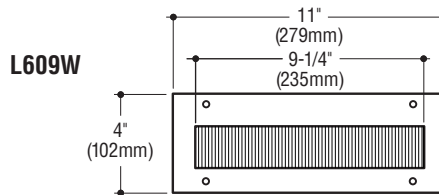
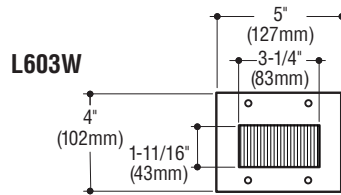

SURFACE

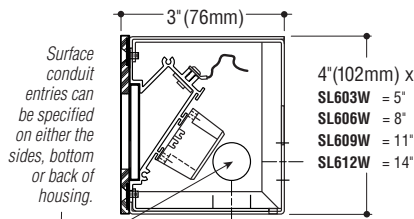

HOUSING WIDTHS for Recessed

- L603W = 4" (102mm) L606W = 7" (178mm)
 L609W = 10" (254mm) L612W = 13" (330mm)

RECESSED

THRU-WALL

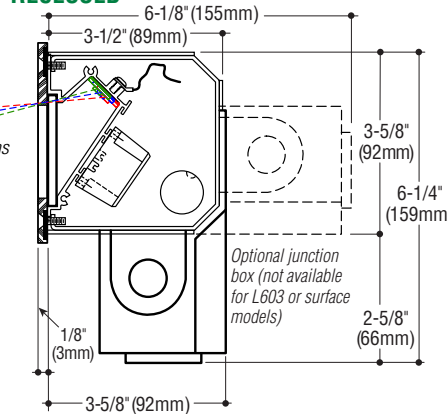
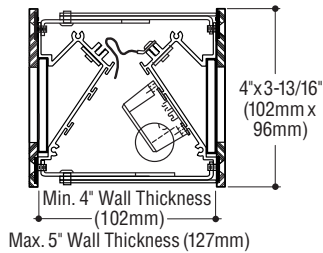

Catalog Number Lamp	Recessed Fixture Faceplate		Thru-Wall Faceplates		Surface Fixture Faceplate	
	Aluminum	Stainless Steel	Aluminum	Stainless Steel	Aluminum	Stainless Steel
LED 1.5w, (126 lm @ 3000°K)*	<input type="checkbox"/> L603W-AL	<input type="checkbox"/> L603W-N	<input type="checkbox"/> L603W-2S-AL	<input type="checkbox"/> L603W-2S-N	<input type="checkbox"/> SL603W-AL	<input type="checkbox"/> SL603W-N
LED 3.5w, (331 lm @ 3000°K)*	<input type="checkbox"/> L603W-AL-HO	<input type="checkbox"/> L603W-N-HO	<input type="checkbox"/> L603W-2S-AL-HO	<input type="checkbox"/> L603W-2S-N-HO	<input type="checkbox"/> SL603W-AL-HO	<input type="checkbox"/> SL603W-N-HO
LED 3.0w, (252 lm @ 3000°K)	<input type="checkbox"/> L606W-AL	<input type="checkbox"/> L606W-N	_____	_____	<input type="checkbox"/> SL606W-AL	<input type="checkbox"/> SL606W-N
LED 6.5w, (662 lm @ 3000°K)	<input type="checkbox"/> L606W-AL-HO	<input type="checkbox"/> L606W-N-HO	_____	_____	<input type="checkbox"/> SL606W-AL-HO	<input type="checkbox"/> SL606W-N-HO
LED 4.5w, (377 lm @ 3000°K)	<input type="checkbox"/> L609W-AL	<input type="checkbox"/> L609W-N	_____	_____	<input type="checkbox"/> SL609W-AL	<input type="checkbox"/> SL609W-N
LED 9.5w, (993 lm @ 3000°K)	<input type="checkbox"/> L609W-AL-HO	<input type="checkbox"/> L609W-N-HO	_____	_____	<input type="checkbox"/> SL609W-AL-HO	<input type="checkbox"/> SL609W-N-HO
LED 6.0w, (503 lm @ 3000°K)	<input type="checkbox"/> L612W-AL	<input type="checkbox"/> L612W-N	_____	_____	<input type="checkbox"/> SL612W-AL	<input type="checkbox"/> SL612W-N
LED 12.5w, (1323 lm @ 3000°K)	<input type="checkbox"/> L612W-AL-HO	<input type="checkbox"/> L612W-N-HO	_____	_____	<input type="checkbox"/> SL612W-AL-HO	<input type="checkbox"/> SL612W-N-HO

*Indicated values for wattage, doubled for thru-wall models.
 Photometric data available for Steplites can be downloaded at: www.colelighting.com/downloads/1

Options

- Junction box:** Cast aluminum junction box. Add suffix -J (Not available on L603 model).
- Dimming:** Universal voltage 0-10V driver. Add suffix -DIM. (Not available on L603 model).
- Cutoff:** 10° or 15°. Add suffix -10° or -15°.
- No Hole:** Fastenerless (not suitable for wet locations). Add suffix -NH
- Frosted glass diffuser:** Tempered. Add suffix -FG

- LED colors:** 4000°K (L603, 146 lm), (L603-HO, 384 lm), (L606, 292 lm), (L606-HO, 768 lm), (L609, 438 lm), (L609-HO, 1152 lm), (L612, 584 lm), (L612-HO, 1535 lm). Add suffix -4K.
- Amber* (FWC compliant, 560 nm). Add suffix -AMB.
- Blue* Add suffix -BLU. *Not available in HO
- Antimicrobial white paint:** Resist microbial growth. Add suffix -AM

- Bronze faceplate:** Satin finished, clear coated. Add suffix -B.
- Alternate trim color:** Black or White. Add suffix -BLK or -WHT, For Custom color or finish.
- Add suffix -CC (consult factory).
- Sensors:** Photocell. Add suffix -PC. Occupancy Sensor. Add suffix -OCC. Button/Switch -SW.