

**JOB NAME** \_\_\_\_\_

**CATALOG NUMBER** \_\_\_\_\_

**Type** \_\_\_\_\_

## Steplites L600 SERIES

### SPECIFICATIONS

#### Construction

- Recessed housing is constructed from 16 gauge electro-galvanized steel, matte black powder-coated
- Surface housing is constructed from 16 gauge satin finished stainless steel or .063" metallic silver powder-coated aluminum
- Faceplates are 3/16" metallic silver powder-coated aluminum or satin finished stainless steel, passivated for maximum rust resistance
- Fixtures are furnished with stainless steel socket head tamperproof screws
- Diffuser is clear tempered glass, set in silicone sealant
- Internal baffle is coated matte black to eliminate glare
- Optional junction box is cast aluminum with polyester coating
- cETLus listed installation in any wall construction and suitable for wet locations in any wall construction
- All models suitable for concrete pour.

#### Electrical

- Fixture is wired with high performance LEDs positioned for 5°, 10° or 15° cutoff (5° standard)
- Integral driver is universal voltage
- Recessed housing provided with 1/2" conduit knockout on each side, suitable for 4 wire thru-wiring, 2 in 2 out. Surface housing conduit entries located per specification
- Optional junction box allows 8 wire thru-wiring, 4 in 4 out. Provided with two 1/2" tapped conduit entrances in the bottom and one 1/2" tapped conduit entrance in each side.

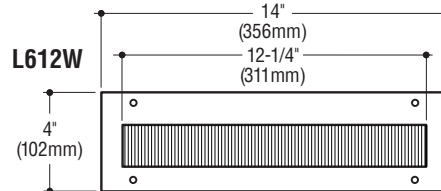
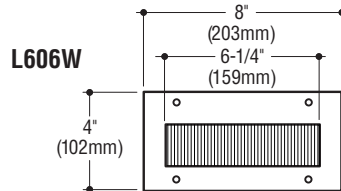
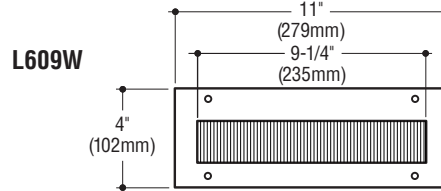
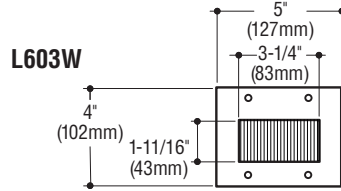

#### SURFACE

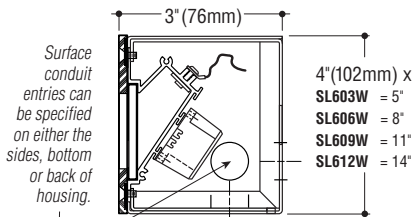

#### HOUSING WIDTHS for Recessed

- L603W = 4" (102mm)    L606W = 7" (178mm)  
L609W = 10" (254mm)    L612W = 13" (330mm)

#### RECESSED

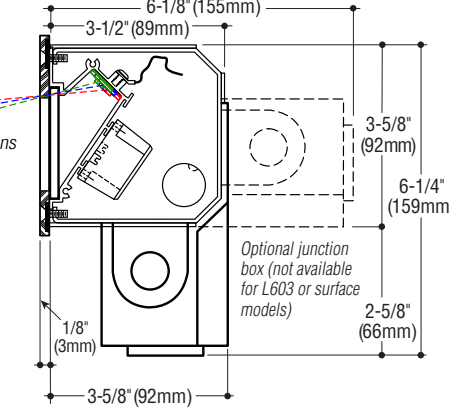

#### THRU-WALL

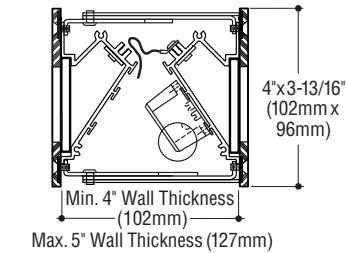

- Std. 5° Cutoff  
10° Cutoff  
15° Cutoff    See options

Optional junction box (not available for L603 or surface models)

Catalog Number Lamp	Recessed Fixture Faceplate		Thru-Wall Faceplates		Surface Fixture Faceplate	
	Aluminum	Stainless Steel	Aluminum	Stainless Steel	Aluminum	Stainless Steel
LED 1.5w, (126 lm @ 3000°K) *	<input type="checkbox"/> L603W-AL	<input type="checkbox"/> L603W-N	<input type="checkbox"/> L603W-2S-AL	<input type="checkbox"/> L603W-2S-N	<input type="checkbox"/> SL603W-AL	<input type="checkbox"/> SL603W-N
LED 3.2w, (331 lm @ 3000°K) *	<input type="checkbox"/> L603W-AL-HO	<input type="checkbox"/> L603W-N-HO	<input type="checkbox"/> L603W-2S-AL-HO	<input type="checkbox"/> L603W-2S-N-HO	<input type="checkbox"/> SL603W-AL-HO	<input type="checkbox"/> SL603W-N-HO
LED 3.0w, (252 lm @ 3000°K)	<input type="checkbox"/> L606W-AL	<input type="checkbox"/> L606W-N	_____	_____	<input type="checkbox"/> SL606W-AL	<input type="checkbox"/> SL606W-N
LED 6.4w, (662 lm @ 3000°K)	<input type="checkbox"/> L606W-AL-HO	<input type="checkbox"/> L606W-N-HO	_____	_____	<input type="checkbox"/> SL606W-AL-HO	<input type="checkbox"/> SL606W-N-HO
LED 4.5w, (377 lm @ 3000°K)	<input type="checkbox"/> L609W-AL	<input type="checkbox"/> L609W-N	_____	_____	<input type="checkbox"/> SL609W-AL	<input type="checkbox"/> SL609W-N
LED 9.6w, (993 lm @ 3000°K)	<input type="checkbox"/> L609W-AL-HO	<input type="checkbox"/> L609W-N-HO	_____	_____	<input type="checkbox"/> SL609W-AL-HO	<input type="checkbox"/> SL609W-N-HO
LED 6.0w, (503 lm @ 3000°K)	<input type="checkbox"/> L612W-AL	<input type="checkbox"/> L612W-N	_____	_____	<input type="checkbox"/> SL612W-AL	<input type="checkbox"/> SL612W-N
LED 12.8w, (1323 lm @ 3000°K)	<input type="checkbox"/> L612W-AL-HO	<input type="checkbox"/> L612W-N-HO	_____	_____	<input type="checkbox"/> SL612W-AL-HO	<input type="checkbox"/> SL612W-N-HO

\* Indicated values for wattage, doubled for thru-wall models.

Photometric data available for Steplites can be downloaded at: <https://www.colelighting.com/photometrics>

Specify conduit entry locations when ordering surface.

**OPTIONS**

- LED colors:** 4000°K (L603, 146 lm), (L603-HO, 384 lm), (L606, 292 lm), (L606-HO, 768 lm), (L609, 438 lm), (L609-HO, 1152 lm), (L612, 584 lm), (L612-HO, 1535 lm). Add suffix  -4K.
- Amber ♦ (FWC compliant, 560 nm). Add suffix  -AMB.
- Blue ♦ Add suffix  -BLU.
- Cutoff:** 10° or 15°. Add suffix  -10° or  -15°.
- Frosted glass diffuser:** Tempered. Add suffix  -FG
- Device:** Button/Switch (606 & 609 only).  -SW.

- No Hole:** Fastenerless (not suitable for wet locations). Add suffix  -NH
- Dimming:** Universal voltage 0-10V driver ★. Add suffix  -DIM.
- Junction box:** Cast aluminum junction box ★. Add suffix  -J
- Emergency battery (4 Watt):** Provides up to 90 min. operation ★. Add suffix  -EM.
- Bronze faceplate:** Satin finished, clear coated. Add suffix  -B.

- Sensors:** Available in 603, 606 & 609 sizes ♦. Photocell. Add suffix  -PC.
- Occupancy Sensor. Add suffix  -OCC.
- Antimicrobial white paint:** Resist microbial growth. Add suffix  -AM
- Alternate trim color:** Black or White. Add suffix  -BLK or  -WHT.
- For Custom color or finish, consult factory. Add suffix  -CC