

## Plugging Boxes

### Interior Applications



The TLS-364 Series provides a straight-sided housing for installation in wood floors.

The TLA-364 Series has an adjustable leveling collar for installation in poured concrete floors.



## 364 SERIES

### Description

The 364 Series Plugging Boxes are recessed floor mounted enclosures designed for the temporary connection of electrical devices in interior concrete pour installations where up to four devices are required. For installations requiring up to two devices, see the 362 Series.

### Features

Cover opens to provide access to devices. Cord slot allows door to remain closed with cord connected. The TLS-364 has straight sides for installation from above in existing wood floors. The TLA-364 is for concrete pour installations and may be adjusted to finished floor level. A barrier allows high voltage and low voltage devices to be installed.

### Applications

The 364 Series Plugging Boxes are for installation in buildings such as schools, churches, theatrical stages, hospitals, civic buildings, offices, and other locations for the connection of lighting, sound and service appliance equipment.

### Custom

If your project demands a special fixture we would be pleased to discuss the production of custom fixtures to suit your specific conditions. For more information on our custom capabilities, please contact your local Cole representative.

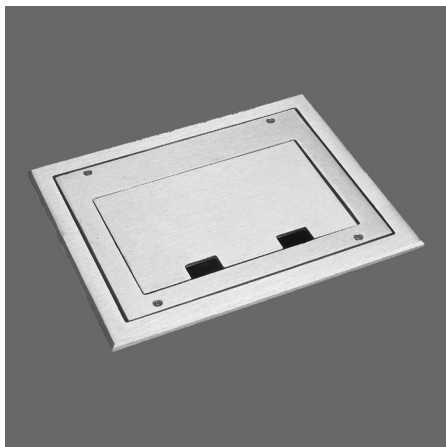

An optional Carpet Flange for the TLA-364 Series includes Finish Trim and provides an overlapping flange for carpeted installations.



C. W. Cole & Company, Inc.  
2560 N. Rosemead Boulevard  
South El Monte, CA 91733-1593

Fax (626) 443-9253  
Tel. (626) 443-2473  
info@colelighting.com  
www.colelighting.com

## Plugging Boxes

### 364 SERIES

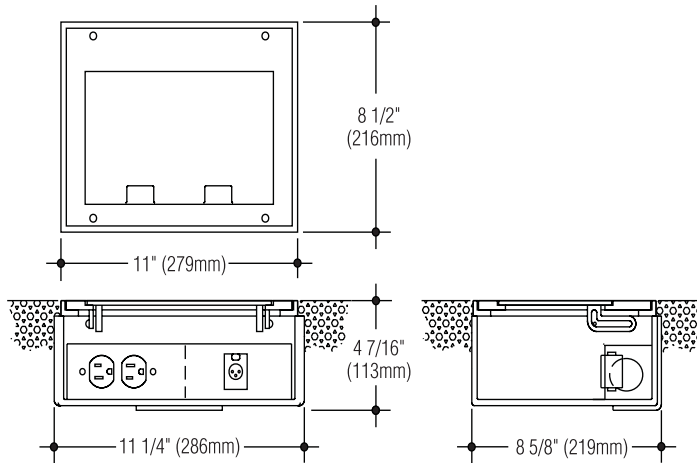

TLA-364 shown. TLS-364 is similar, except 10 5/8" x 8 1/8" x 4 1/4" (270 x 206 x 108 mm)

#### Specifications

##### Construction

- Cover is cast aluminum
- Standard cover door has non-skid grid and is self-closing with a cord slot
- Cover is finished with black polyester powder
- Models with Finish Trim or Carpet Flange option have smooth surface with satin aluminum finish
- TLA-364: housing and leveling collar are cast aluminum
- TLS-364: housing is 16 gauge steel







##### Electrical

- Various wiring devices or combinations are available as indicated with catalog suffixes
- Units with multiple-voltage devices have metal interior barrier between compartments
- TLA-364 housing has two 1/2" trade-size tapped conduit entrances
- TLS-364 housing has six 1/2"-3/4"-1" six combination trade size conduit entrances
- Listed by cETLus

##### Mounting

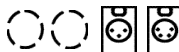
- TLS-364: Box designed to be recessed in hardwood floors with no overlap. Particularly suitable for installation in existing floors where box flexes with floor
- TLA-364: Box designed for poured concrete floors. Frame, with leveling screws, is adjustable and is designed for dry-pack grout after cover is leveled to finished floor.

#### Catalog Numbers

Blank interior. No devices furnished	TLS / TLA-364
Duplex U-ground power outlet on one side. 15 amp, 125 volt	TLS / TLA-364-1 
Duplex 3-wire twist-lock outlet on one side. 15 amp, 125 volt	TLS / TLA-364-2 
Single 3-pole microphone outlet and single 4-pole speaker outlet on one side. Low voltage	TLS / TLA-364-3 
Duplex U-ground outlet on one side. Single 3-pole microphone outlet and single 4-pole speaker outlet on other side. 15 amp, 125 volt. Low voltage	TLS / TLA-364-4 
Duplex 3-wire twist-lock power outlet on one side. Single 3-pole microphone outlet and single 4-pole speaker outlet on other side. 15 amp, 125 volt. Low voltage	TLS / TLA-364-5 
Two single U-ground power outlets (NEMA 5- 20) one side. 20 amp, 125 volt	TLS / TLA-364-6 
Additional combinations of above or other stan- dard wiring devices (maximum of 4) as required. Specify complete requirements	TLS / TLA-364-6

#### Options

- Bronze:** Satin finished red brass. Add suffix **-B**.
- Carpet Flange:** Includes Finish Trim. Add suffix **-CF**.
- Dust Cover Over Outlets:** Add suffix **-D**.
- Cast Iron Housing:** Add suffix **-FE**.
- Finish Trim:** Add suffix **-FT**.

#### How to Specify

1. Select catalog number with desired features.
2. Add suffixes for options required to meet job conditions.



**C. W. Cole & Company, Inc.**  
2560 N. Rosemead Boulevard  
South El Monte, CA 91733-1593

Fax (626) 443-9253  
Tel. (626) 443-2473  
info@colelighting.com  
www.colelighting.com