

Illuminated Handrails

LIGHTRAIL • LR 2

LR 2W Wall Mounted
LR 2P Post Mounted

Description

LR 2 Series Lightrail is a flexible system of wall or post mounted illuminated handrails with a symmetrical design. It projects illumination equally to both sides. LR 2 Series Lightrail is complementary to the LR 1 Series, which should be used when an asymmetrical light pattern is required. Companion non-illuminated Lightrail is also available for this series. Design features comply with ADA and other codes.

Features

A high impact acrylic lens provides a symmetrical illumination pattern that effectively washes walkways with light to both sides. To ease maintenance the lens prisms are on the lamp side. Illumination is provided by T8 fluorescent lamps with the ballasts positioned above the lamps to maximize continuous uninterrupted light. The heavy extruded aluminum rail is welded at all intersections and features cast and extruded aluminum wall mounting brackets or extruded aluminum posts. The optional grip rail with smaller dimensions meets ADA requirements.

Applications

LR 2 Lightrail is ideal as guardrails, stair and ramp railings as well as elevator railings.

Custom

We would be pleased to discuss the production of modified standard Lightrail or custom railings to suit your specific conditions. Modifications possible include custom extrusions, alternate finishes or materials, mounting adaptations, end treatments and alternate light sources.

To learn more about our custom capabilities and standard product lines call us directly or contact your local Cole representative.



LR 2 Lightrail produces a symmetrical light distribution pattern that washes walkways with light to both sides.

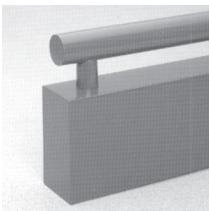
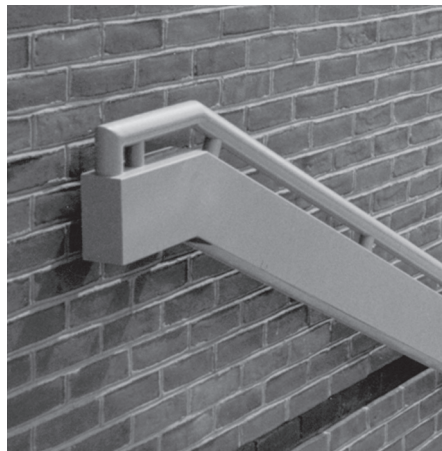

Optional grip rail may be specified for mounting on the top of the Lightrail when required by ADA or other codes.

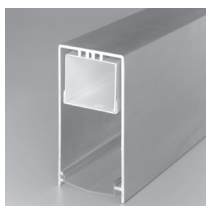

C. W. Cole & Company, Inc.
2560 N. Rosemead Boulevard
South El Monte, CA 91733-1593

Fax (626) 443-9253
Tel. (626) 443-2473
info@colelighting.com
www.colelighting.com

Illuminated Handrails

LIGHTRAIL • LR 2

LR 2W Wall Mounted
LR 2P Post Mounted

Specifications

Construction

- Railing is extruded .125" wall, 6063-T5 aluminum
- Posts are 3" square, .125" wall extruded aluminum tubing
- Wall brackets are 4" square at electrical feed locations, 4" x 2" at other locations
- Brackets are .125" wall extruded aluminum tube with cast aluminum wall plate
- Clear, prismatic snap-in lens is extruded high-impact acrylic with prisms on the inside for better maintenance
- Ends and all railing miters are welded and ground smooth
- Optional grip rail is 1.66" diameter x 0.19" wall aluminum pipe
- Medium bronze polyester coating is the standard finish; other colors and finishes are available.

Electrical

- Prewired for T8 rapid start fluorescent lamps with 120V-277V standard (347V available), 0° F (-18° C) electronic ballasts
- Lamping will be determined by the factory to ensure maximum even illumination
- Other lamping available for special applications
- Ballasts in LR 2 models are above lamps, permitting uninterrupted illumination
- cULus listed suitable for wet locations.

Mounting

- Posts are provided to a maximum of 8' centers, wall brackets provided up to 6' centers, subject to spacing requirements of the particular installation
- Posts are provided with extra 6" length for direct burial and 4" square x 6" styrofoam forms for pre-casting hole; contractor to finish with quick-setting concrete
- 6" x 6" x 3/8" baseplate with four 5/8" holes is available as an option
- 4" square wall bracket allows mounting over conduit stub
- Wall bracket mounting bolts (by others) are concealed.



C. W. Cole & Company, Inc.
2560 N. Rosemead Boulevard
South El Monte, CA 91733-1593

Fax (626) 443-9253
Tel. (626) 443-2473
info@colelighting.com
www.colelighting.com

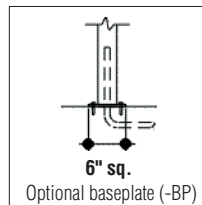
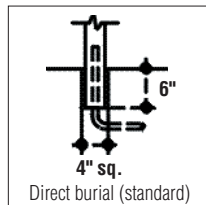
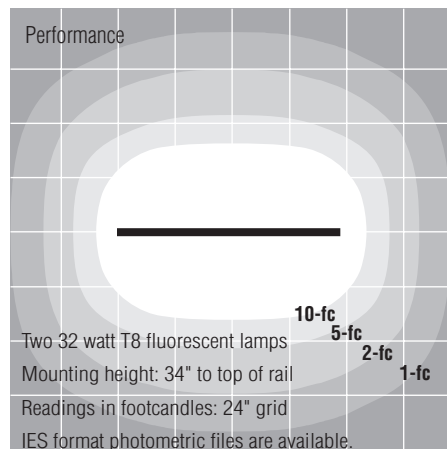
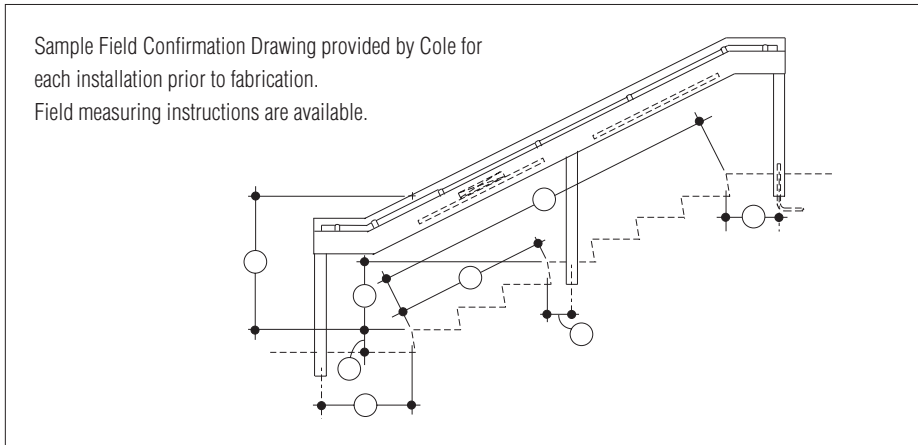
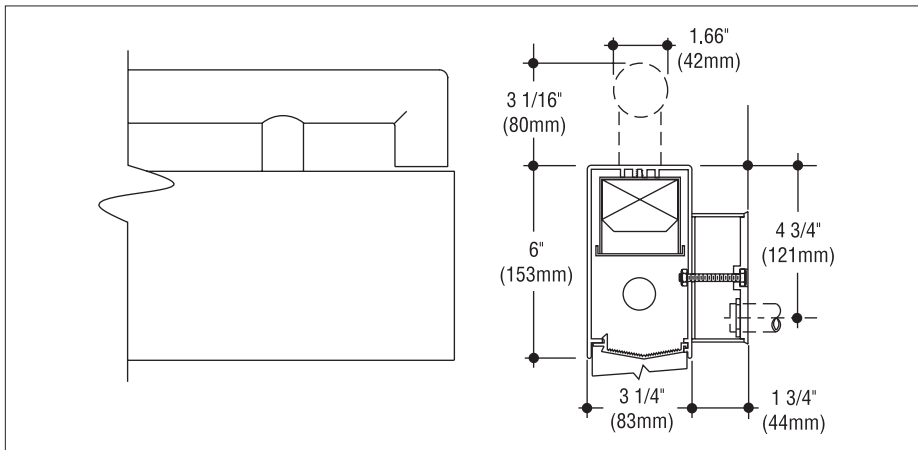

Options

- Grip rail:** 1.90" diameter. Add suffix **-H**.
- Baseplate:** 6" x 6" x 3/8" baseplate with four 5/8" holes. Add suffix **-BP**.
- Pickets:** 3/4" pickets, 4 3/4" on center, top rail 4" below bottom of Lightrail, bottom rail 4" above ground. Add suffix **-K**.
- Non-illuminated:** Without lighting components. Add suffix **-U**.
- Finishes:** Special finishes are available; contact factory.
- Emergency Battery:** Provides battery operation for up to 90 minutes during power outage for all or selected lamps. Add suffix **-EM**.

How to Specify

- Every Lightrail is custom designed and fabricated to your specific project conditions. Architectural drawings are required that clearly show the desired configurations and locations. A detailed drawing (similar to the sample above) will be provided by Cole prior to fabrication for your field verification.
1. Give catalog number, options, and voltage. Example: LR 2W-H-277. Lamping will be determined by the factory to maximize even illumination.
 2. Select desired options and add appropriate suffixes.