

LIGHTRAIL™

Illuminated Handrail

United Unions
Washington, DC

Pioneering creative solutions in illuminated handrails since 1972

COLE
Lighting
...since 1911



Yankee Stadium
Bronx, NY

LIGHTRAIL™

Pioneering creative solutions in illuminated handrail since 1972



**Yankee Stadium
Bronx, NY**

Cole Lightrail™ systems are versatile and functional illuminated handrails, suitable for exterior or interior stair, ramp or guardrail applications. Lightrail™ is available in symmetrical and asymmetrical light distribution patterns, projecting light where it is needed. Lightrail™ may be wall or post mounted with integral or remote power supplies. Additionally, mounting provisions may be furnished for coordination with another railing manufacturer—such as for the attachment to a guardrail. Matching non-illuminated railings are also offered for each series. Cole Lightrail™ is specifically designed and fabricated for each installation. Lightrail™ is designed and engineered to withstand the abuse typical in

public areas. The high impact acrylic diffusers are regressed within heavy duty stainless steel or extruded aluminum housings. All rails are seam-welded and ground smooth allowing one-piece, seamless construction. Modified or custom illuminated railings can be developed to your exact specifications. Cole Lightrails™ are Underwriters' Laboratories (cULus) listed for use in wet locations. Design features comply with the Americans with Disabilities Act (ADA) and other applicable codes. To learn more about our custom capabilities and comprehensive range of standard lighting fixtures, call us or your local Cole representative.



LR5

Post Treatments

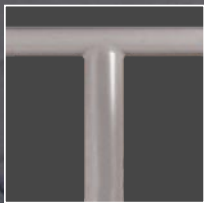

Coped
Standard for Remote
Power Supply

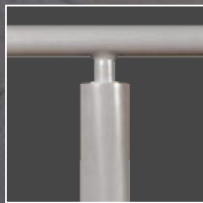

Tenon
Standard for Integral
Power Supply



Radius End (-RE)
As shown for remote
power supply application

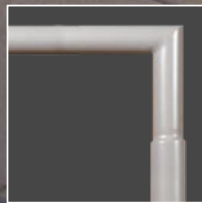

Miter End (-ME)
As shown for integral
power supply application

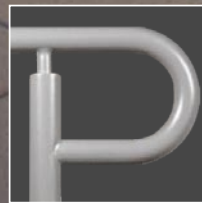

Loop End (-LE)
As shown for integral
power supply application

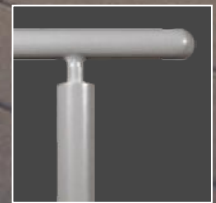

Stub End (-SE)
As shown for integral
power supply application

End Treatments



Huntington Library-Munger Center
San Marino, CA

LR5

LR5P Post Mounted
LR5W Wall Mounted

Description

LR5-LED Lightrail™ Series is a complete illuminated handrail system, ideal for indoor or outdoor applications such as stairs, ramps, and walkways. The round design provides symmetrical or asymmetrical illumination with dimensions that conform to ADA requirements. Lightrail™ is offered in post or wall mount configurations, with integral or remote power supplies. Other uses include the integration of illumination for balustrade, guardrail, and elevator hand-holds.

Construction

Available in extruded aluminum and formed stainless steel with welded and blended joints for a seamless appearance • A high impact diffuser snaps into place and is further retained by fasteners • The flat lens design minimizes visible brightness at sides and is available clear or frosted • Each rail is tailored to fit existing stairs, ramps, and walkways • Aluminum rails supplied with a powder coat finish • Stainless steel rails supplied with a #4 satin finish, passivated for maximum rust resistance • Post and bracket

mounting: 6' max. • Rail height: 36" • Diameter of post with integral driver is 2.375" O.D., diameter of post with remote driver matches rail housing choice • Listed by cULus as suitable for wet locations.

Special Features

Custom mounting brackets and end treatments are available to meet most design criteria • Stainless steel cable, glass panel and wire mesh infills available.

Rail Choices

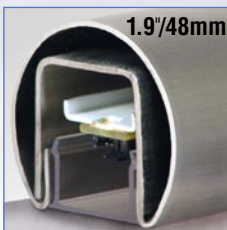

1.9"/48mm

Formed Stainless Steel

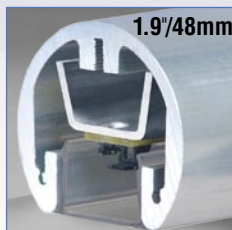

1.9"/48mm

Extruded Aluminum

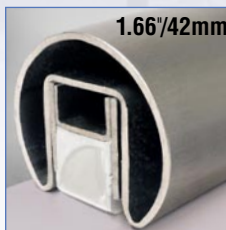

1.66"/42mm

Formed Stainless Steel

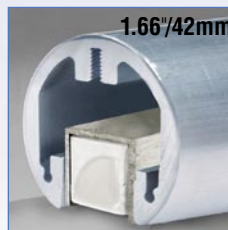

1.66"/42mm

Extruded Aluminum

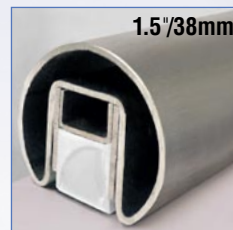

1.5"/38mm

Formed Stainless Steel

Federal Courthouse
Mobile, AL

LR6

Post Treatment

End Treatments



Seamless Joint
Standard for Remote
Power Supply



Tenon
Standard for Integral
Power Supply

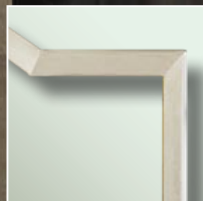

Miter End (-ME)
with easement

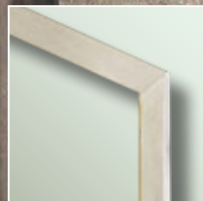

Miter End (-ME)
end-of-rail only



Loop End (-LE)
As shown for Integral
power supply application



Hook End (-HE)
As shown for Remote
power supply application



Claremont-McKenna College
Claremont, CA

LR6

LR6P Post Mounted
LR6W Wall Mounted

Description

LR6-LED Lightrail™ Series is a complete illuminated handrail system, ideal for indoor or outdoor applications such as stairs, ramps, and walkways. The square design provides symmetrical or asymmetrical illumination with dimensions that conform to ADA requirements. Lightrail™ is offered in post or wall mount configurations, with integral or remote power supplies. Other uses include the integration of illumination for balustrade, guardrail, and elevator hand-holds.

Construction

Available in extruded aluminum and formed stainless steel with welded and blended joints for a seamless appearance • A high impact extruded acrylic diffuser snaps into place and is further retained by fasteners at each end • The flat lens design minimizes visible brightness at sides and is available in clear or frosted

- Each rail is tailored to fit existing stairs, ramps, and walkways
- Aluminum rails supplied with a powder coat finish
- Listed by cULus as suitable for wet locations
- Stainless steel rails supplied with

- a #4 satin finish, passivated for maximum rust resistance
- Post/brackets mounting: 6' max.
- Rail height: 36".

Special Features

Custom mounting brackets and end treatments are available to meet most design criteria. Stainless steel cable, glass panel and mesh panel infills also available.

Rail Choices



Formed Stainless Steel



Extruded Aluminum

Seamless One-Piece Construction

Cole Lightrail™ combines an elegant appearance with easy, efficient installation. All rails are one-piece, seam-welded with the welds ground smooth. There are no visible seams to reveal the lighting-fixture origins. Additionally, each rail is shipped prewired, ready to install. If integral power supplies are specified, flush-fitting access covers are located in selected posts or, in some instances, access covers are concealed underneath the rail.

***Most rails are shipped one-piece, ready to install.
All rails are shipped prewired,
no assembly required***

Huntington Library
San Marino, CA

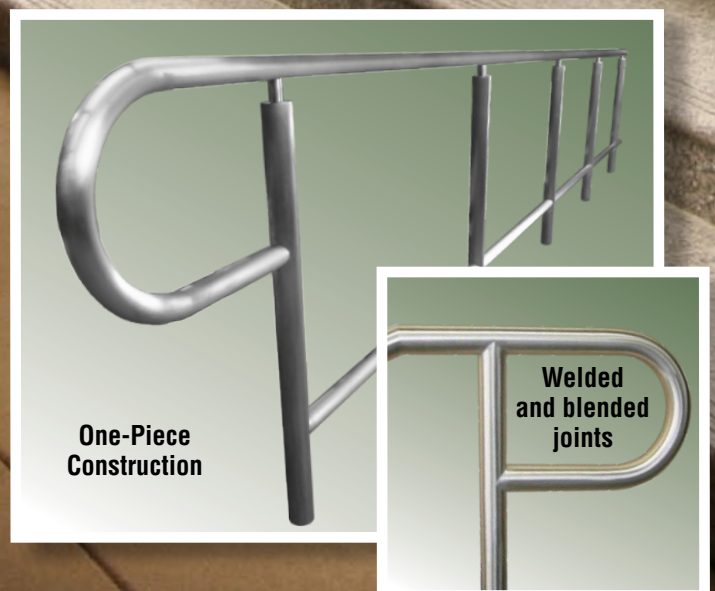



LR5 shown with custom post and skateboard deterrent.

Skateboard Deterrent

Functional “speed bumps”, attached to the top of the rails, discourages skateboard grinding and the damage it can cause.

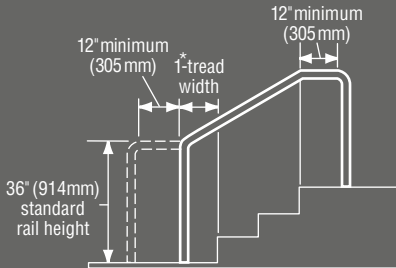

Return to Walking Surface

**Horizontal extension not required for ADA.*

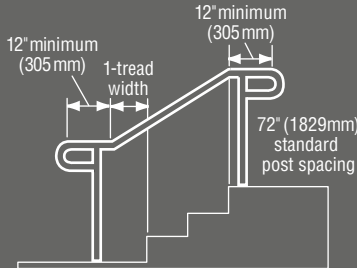

Return to Post

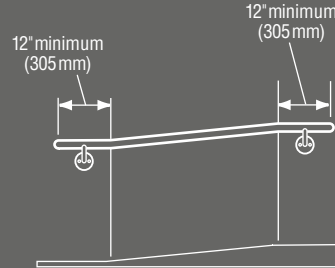

Wall Mounted Ramp Rail

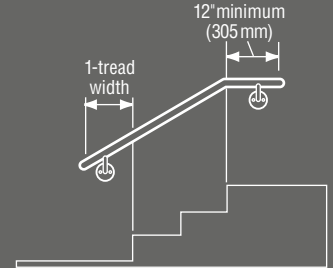

Return to Wall



Santa Monica Place - Santa Monica, CA

ADA Compliant

Americans with Disabilities Act

The 2010 ADA Standards for Accessible Design requires the top of the gripping surface to be 34"/865mm minimum and 38"/965mm maximum vertically above the walking surfaces, stair nosings, and ramp surfaces. Handrails with circular cross sections are to be 1¼"/32mm minimum and 2"/51mm maximum diameter. Handrails with non-circular cross sections are to have a perimeter dimension of 4"/100mm minimum and 6¼"/160mm maximum, with a cross section dimension of 2¼"/57mm maximum. For ramps and stairs there is to be a 12"/305mm minimum horizontal extension at the top end beginning directly over the end of the ramp or the first riser nosing. There is to be a 12"/305mm minimum horizontal extension beginning directly at the end of the ramp. At the bottom of stairs, handrails are to extend at the slope of the stair flight for a horizontal distance equal to one tread depth beyond the last stair nosing. At ends, rails are to return to landing surface, wall or post.

INFILLS

Light Rail Transit
Calgary, Alberta Canada

INFILLS

Infill materials are available in glass, mesh, stainless steel cable or other suitable materials of your choice. Standard attachment methods are surface, side and weld mounts. Custom attachment methods are available.



Glass Panel

Hardware included to accommodate most panel thickness. Glass not included.



Mesh Panel

A variety of welded, weave and expanded metal pattern options available. Finishes, colors and metal types offered to match handrail choice.



Stainless Steel Cable

Surface mounted or side mounted cable. Accessory: tensioners, cable sleeves, turnbuckles, including stud, lag stud, stop, and swivel end assembly fittings available.

LR5 LED

RED = Standard Light Cut-off

PURPLE = 30° Orientation

Formed Stainless Steel

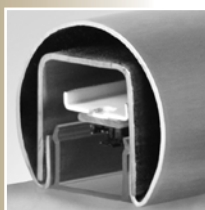

1.90"

Dimensions



Symmetric

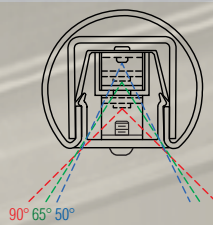

Asymmetric (-ASYM)

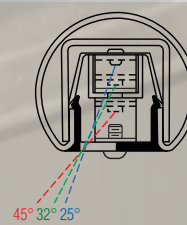

Asymmetric (-ASYM/30°)

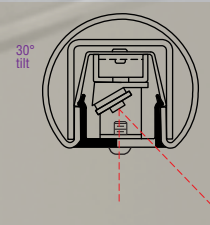

1.66"

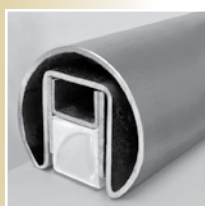
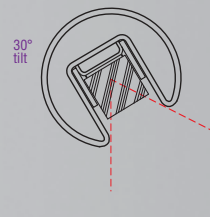
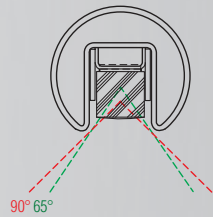

1.50"

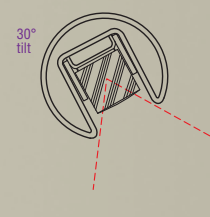
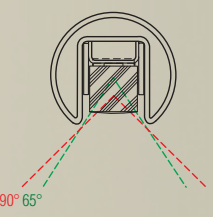

Alphabet
ZETA750 Puck
Supplemental
Brochure



Extruded Aluminum

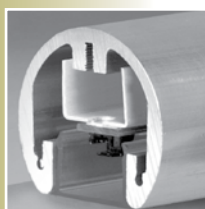

1.90"

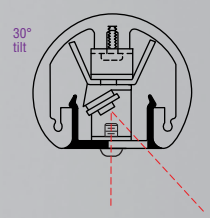
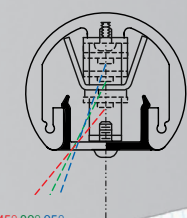
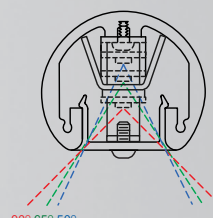
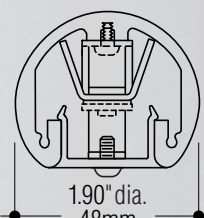

1.66"

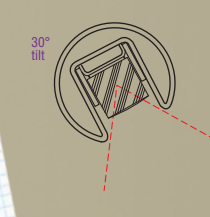
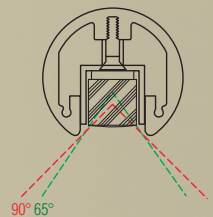
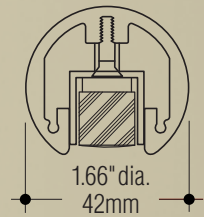

ELECTRICAL INFORMATION

Page 19

- Voltage
- Lumens
- Watts
- Drivers
- CCT
- LEDs
- CRI

Standard LR5 Mounts

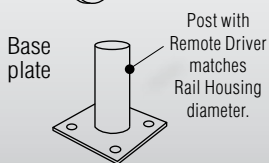
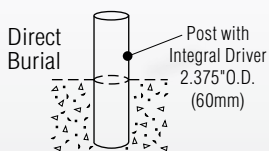

Catalog Number

- Post mounted, integral driver
- Post mounted, remote driver
- Wall mounted, integral driver**
- Wall mounted, remote driver

Stainless Steel (-SS)

- LR5P -LED-SS/*-INT
- LR5P -LED-SS/*-REM
- LR5W-LED-SS/1.9-INT
- LR5W-LED-SS/*-REM

Aluminum (-AL)

- LR5P -LED-AL/*-INT
- LR5P -LED-AL/*-REM
- LR5W-LED-AL/1.9-INT
- LR5W-LED-AL/*-REM

* Insert choice of rail diameter after slash, 1.9", 1.66" or 1.5"

** Limited driver capacity allows for only 1.9" rail choice.

LR5 Options

Ends: Add suffix. Radius **-RE**, Loop **-LE**, Extended Loop **-ELE**, Miter **-ME**, Stub **-SE**.

Baseplate: Nominal 4" diameter or 4" square baseplate with four mounting holes.

Add suffix **-BP**.

Escutcheon: Add suffix **-ES**.

Frosted lens: (clear diffuser std.). Add suffix **-FL**.

Curved rail: Consult with factory. Add suffix **-CRV**.

ADDITIONAL
OPTIONS
Page 21

Emergency battery: Provides up to 90 min. of operation. (remote models only). Add suffix **-EM**.

Asymmetric distribution: 50% opaque (not available on all models). Add suffix **-ASYM**. or 30° tilt **-ASYM/30°**.

4100°K Color temperature: (3000°K std.). Add suffix **-4K**.

Color LED: FWC compliant, 590nm Amber. Add suffix **-AMB**.

Beam spread: (90° std.). 65°, Add suffix **-65**. 50°, Add suffix **-50**. (50° only available for 1.9" size rail)

Dimming: Universal voltage 0-10V driver. Add suffix **-DIM**

End Treatments

LR5

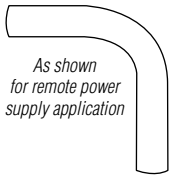

As shown for remote power supply application

Radius End (-RE)

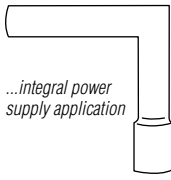

...integral power supply application

Miter End (-ME)

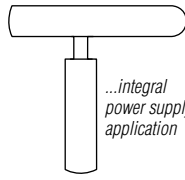

...integral power supply application

Stub End (-SE)

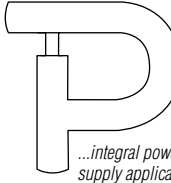

...integral power supply application

Loop End (-LE)

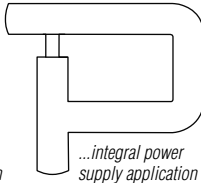

...integral power supply application

Extended Loop End (-ELE)

CUSTOM LR5/LR6 END & POST TREATMENTS OPTIONAL

LR6

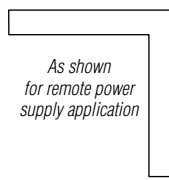

As shown for remote power supply application

Miter End (-ME)

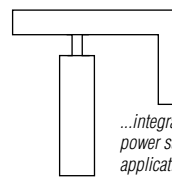

...integral power supply application

Hook End (-HE)

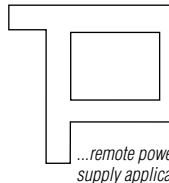

...remote power supply application

Loop End (-LE)

Escutcheon Options

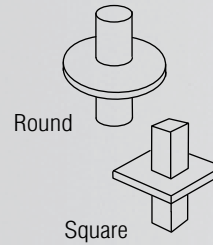

Post Treatments

LR5 & LR6

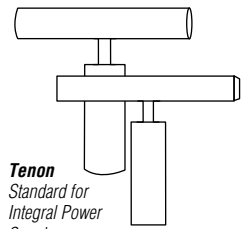

Tenon
Standard for Integral Power Supply

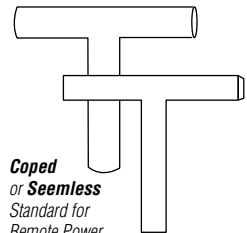

Coped or Seemless
Standard for Remote Power Supply

LR6 LED

Formed Stainless Steel

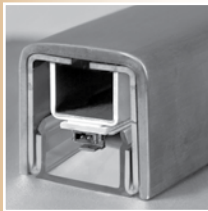

1.50"

Dimensions

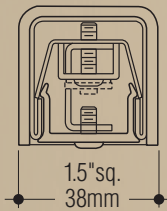

Symmetric

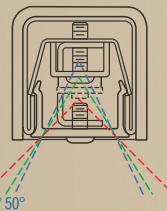

Asymmetric (-ASYM)

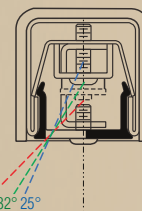

Asymmetric (-ASYM/30°)

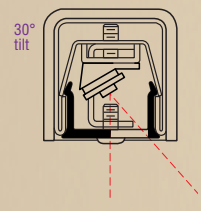

Extruded Aluminum



1.50"

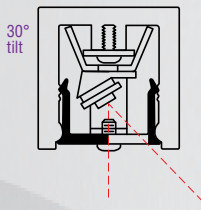
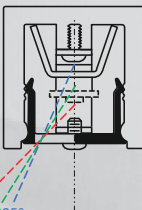
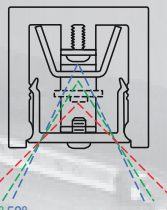
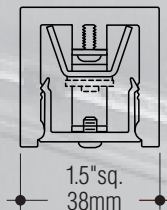

Standard LR6 Mounts

Direct Burial

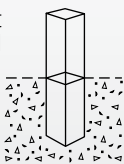

Wall

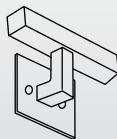

Base plate

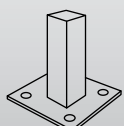

Catalog Number

Post mounted, integral driver
Post mounted, remote driver
Wall mounted, integral driver
Wall mounted, remote driver

Stainless Steel (-SS)

LR6P-LED-SS-INT
LR6P-LED-SS-REM
LR6W-LED-SS-INT
LR6W-LED-SS-REM

Aluminum (-AL)

LR6P-LED-AL-INT
LR6P-LED-AL-REM
LR6W-LED-AL-INT
LR6W-LED-AL-REM

LR6 Options

Ends: Add suffix. Miter **-ME**, Loop **-LE**, Extended Loop **-LE**, or Hook **-HE**.

Baseplate: Nominal 4" diameter or 4" square baseplate with four mounting holes. Add suffix **-BP**.

4100°K Color temperature: (3000°K std.). Add suffix **-4K**.

ColorLED: FWC compliant, 590nm Amber. Add suffix **-AMB**.

Frosted lens: (clear diffuser std.). Add suffix **-FL**.

ADDITIONAL OPTIONS
Page 21

Escutcheon: Add suffix **-ES**.

Asymmetric distribution: 50% opaque.

Add suffix **-ASYM** or 30° tilt **-ASYM/30°**.

Emergency battery: Provides up to 90 min. operation. (remote models only). Add suffix **-EM**.

Beam spread: (90° std.). 65°, Add suffix **-65**. 50°, Add suffix **-50**.

Dimming: Universal voltage 0-10V driver. Add suffix **-DIM**

ELECTRICAL INFORMATION
Page 19

MOUNTING



Standard Mounts

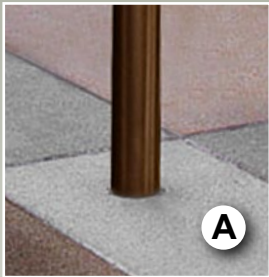

Direct Burial Mount

Embedded below concrete surface and set in non-shrink grout by contractor.

Escutcheon options: Round escutcheon for LR5 and square for LR6.

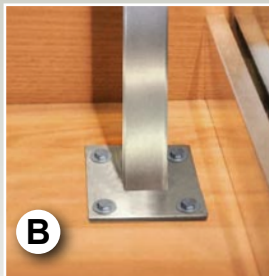
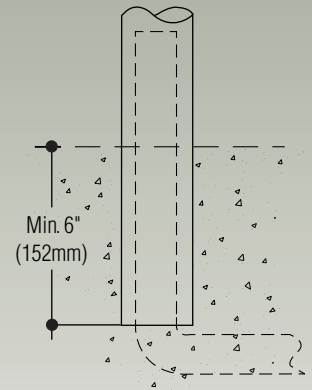
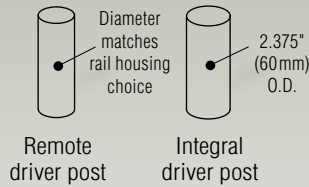

Baseplate Mount

Baseplate secured in place by four mounting holes. Mounting hardware not provided.

Escutcheon options: Round escutcheon for LR5 and square for LR6.

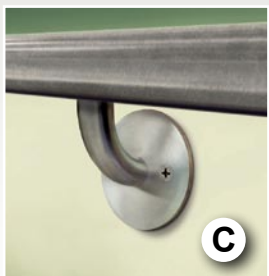
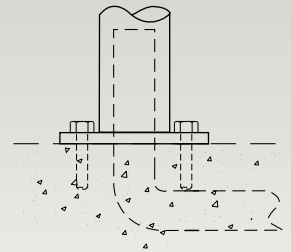
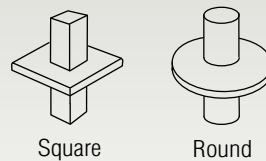

Wall Mount

Custom mounting brackets and end treatments are available to meet most design criteria. Mounting hardware not provided. Perpendicular orientation standard; vertical orientation optional.

Post/bracket mounting not to exceed 6' on center.

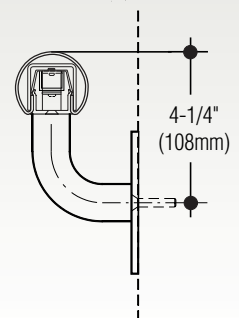



Illinois Governor's Mansion
Springfield, IL



Decorative Flat Shoe Mount



Lambs Tongue Rail End



Moulded Cap Rail

Traditional Lightrail - LR7/LR8



University of Michigan
Ann Arbor, MI

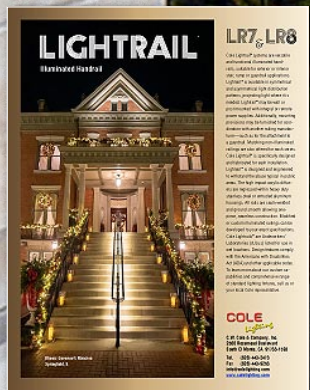

LR7 & LR8
Lightrail
Brochure

POWER SUPPLY

Remote Driver

Choosing remote power supplies allows a more sleek post-to-rail design at a more attractive price point than integral power. Posts and rails will share the same dimensional cross-section. Cole offers driver options which may include up to 100 watt capacity, wet location capability, and 0-10 volt dimming. Any post or wall bracket location is available as an electrical feed entry-point. 40 feet of rail could be illuminated by one remote driver location. A driver-to-LED by wire gauge distance chart is available for download. Wet location rated stainless steel driver enclosures, suitable for surface or recessed mounting, are furnished as standard. Each job will be uniquely optimized to meet desired specifications.

Sleek post-to-rail.

Post diameter with remote driver matches rail housing choice

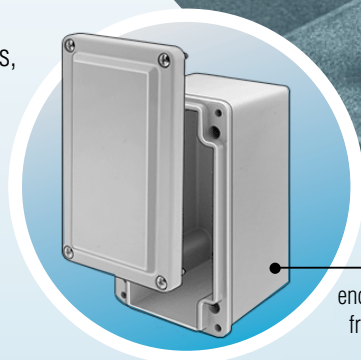

Submersible enclosures for protection from dirt, washdowns, corrosions and water submersion.



Stainless steel driver enclosure suitable for installation in poured concrete and wet locations.

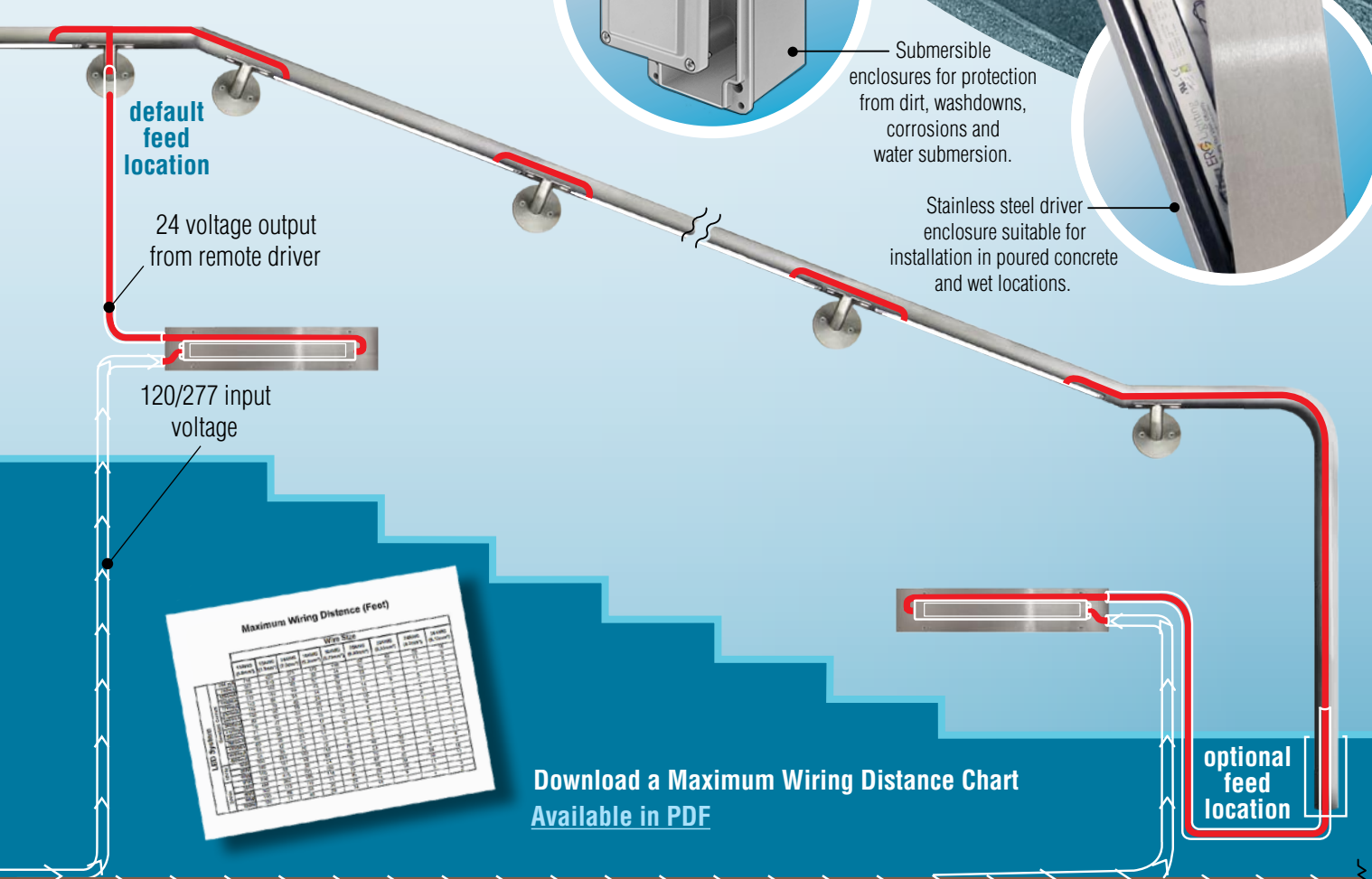

Maximum Wiring Distance (Feet)

Wire Size	120V		277V	
	100% Dimming	0-10V Dimming	100% Dimming	0-10V Dimming
14 AWG	100	100	100	100
12 AWG	150	150	150	150
10 AWG	200	200	200	200
8 AWG	300	300	300	300
6 AWG	400	400	400	400
4 AWG	600	600	600	600
3 AWG	800	800	800	800
2 AWG	1000	1000	1000	1000
1 AWG	1500	1500	1500	1500
3/4 AWG	2000	2000	2000	2000
1/2 AWG	3000	3000	3000	3000
4 AWG	4000	4000	4000	4000
3 AWG	6000	6000	6000	6000
2 AWG	8000	8000	8000	8000
1 AWG	12000	12000	12000	12000

Download a Maximum Wiring Distance Chart Available in PDF

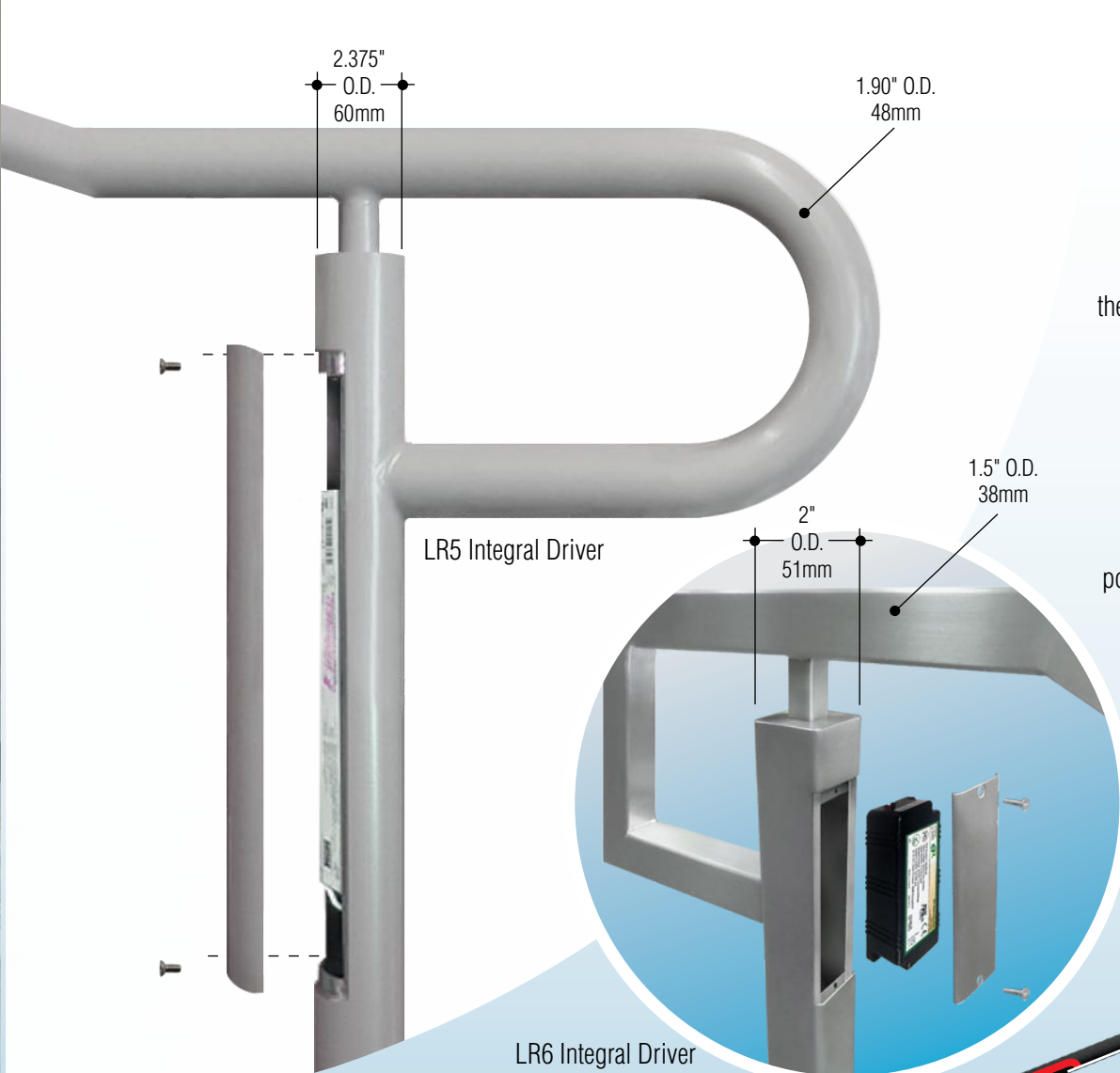

LR5 Integral Driver

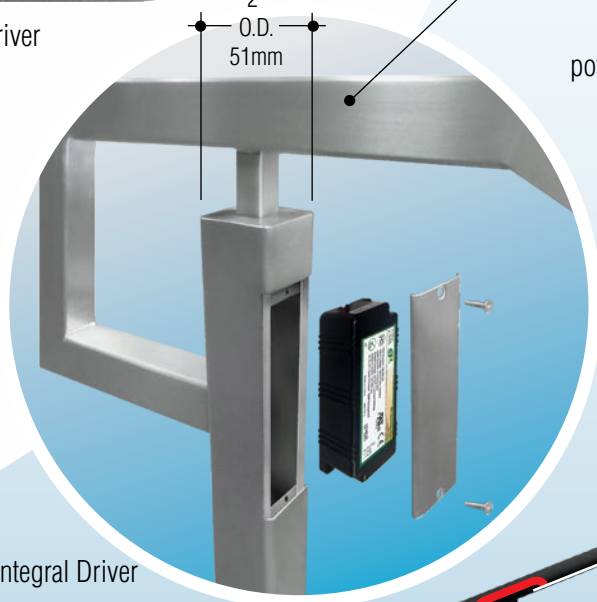

LR6 Integral Driver

Integral Driver

For the ultimate in convenience for the specifier, engineer, and contractor alike, Cole offers integral power supplies. Drivers can be located in specially-designed posts with flush-mounted access covers. Multiple posts can be used for this purpose, each location potentially powering up to 40 feet of illuminated rail. Whichever integral driver option is selected, each job will be uniquely optimized to meet desired specifications.

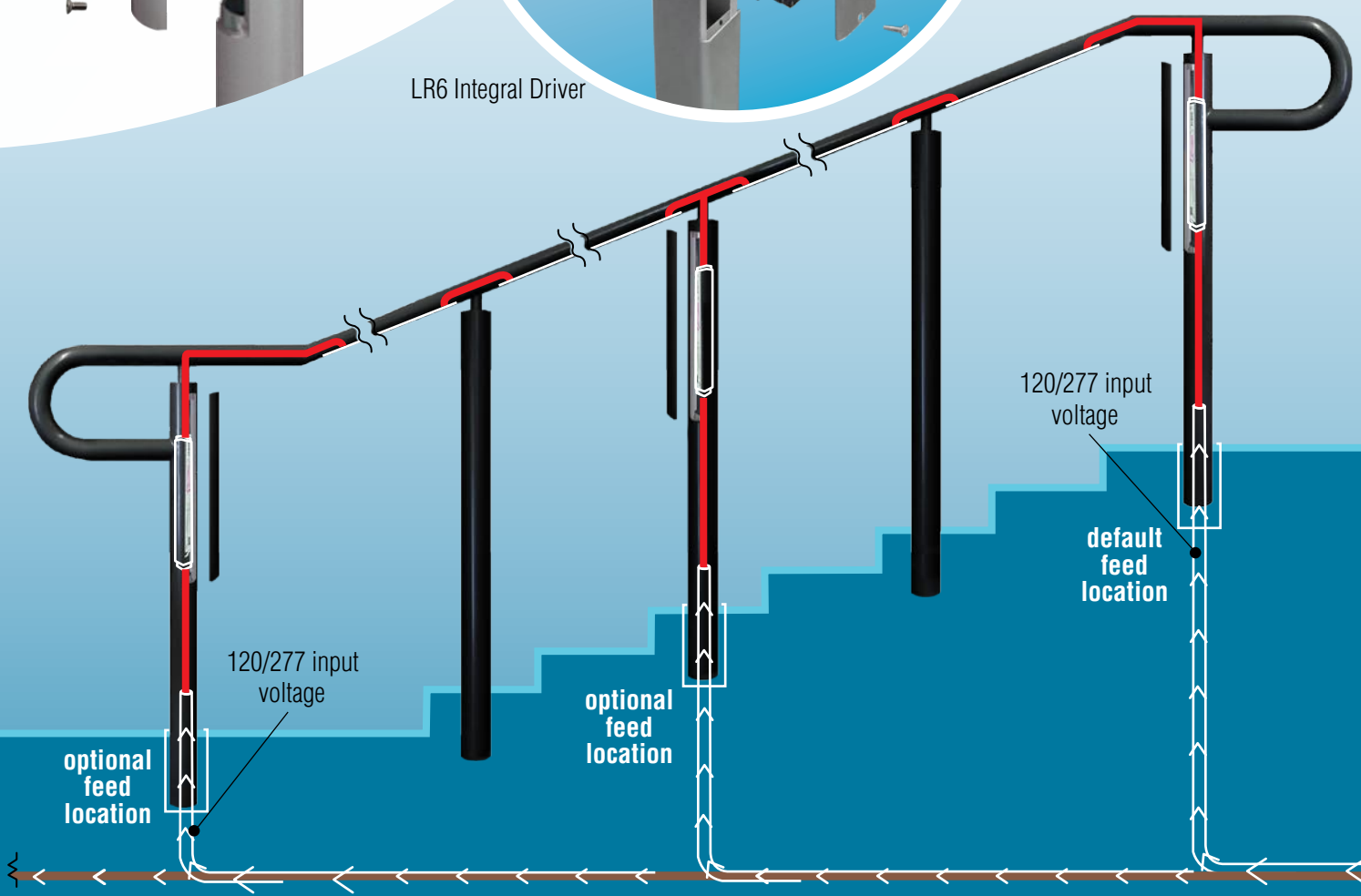

PHOTOMETRY

LR5/1.9 - LR6 Symmetric

48" Long Test Sample
Clear acrylic lens*

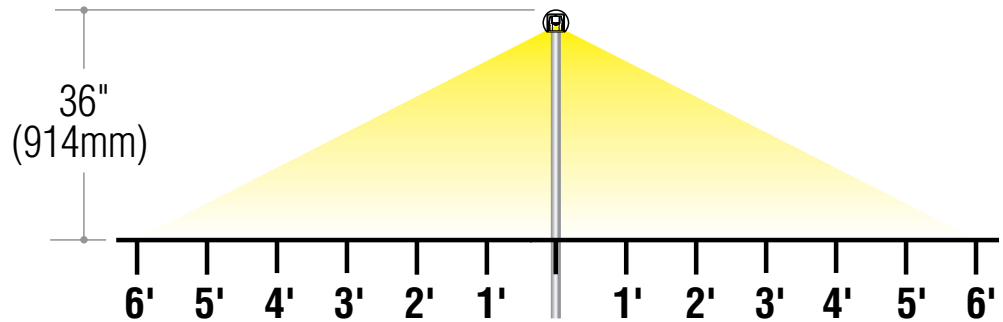

LR5/1.9 - LR6 Asymmetric

48" Long Test Sample
Clear acrylic lens*

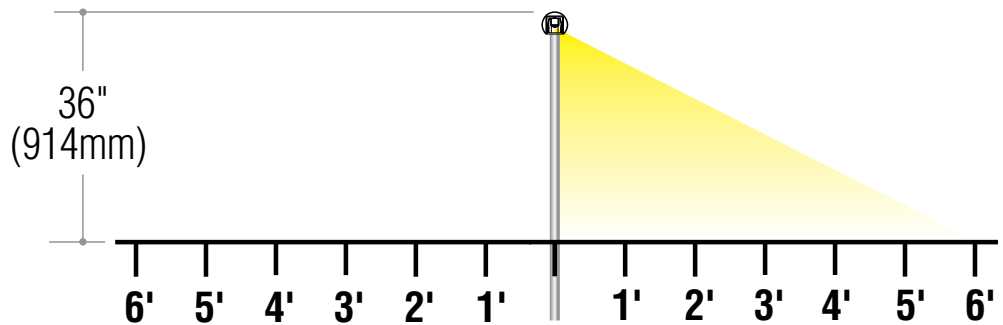

LR5/1.9 - LR6 Asymmetric/30°

48" Long Test Sample
Clear acrylic lens*

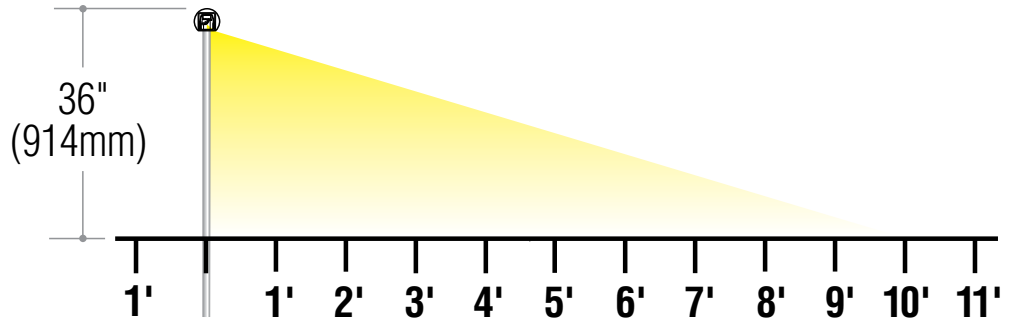

*.72 Frosted lens multiplier

Photometry downloads (zip compressed files)

LR5

[LR5-1.9 Symmetric, Clear lens - Standard](#)

[LR5-1.9 Symmetric, Frosted lens \(-FL\)](#)

[LR5-1.9 Asymmetric, 30° tilt \(-ASYM/30°\)](#)

[LR5-1.66/1.5 Symmetric - Standard](#)

[LR5-1.66/1.5 Symmetric \(-LED/HO\)](#)

LR6

[LR6-1.5 Symmetric, Clear lens - Standard](#)





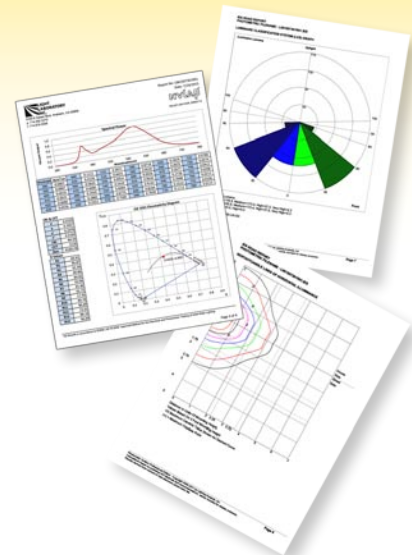

[LR6-1.5 Symmetric, Frosted lens \(-FL\)](#)

[LR6-1.5 Asymmetric, 30° tilt \(-ASYM/30°\)](#)

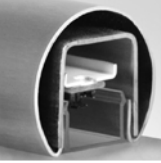

ELECTRICAL

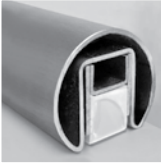
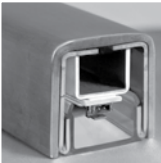

LR5					
	Voltage	Watts PER FOOT	Lumens PER FOOT	CCT	CRI
1.90"  Stainless Steel  Aluminum	120 - 277V Universal voltage (Driver)	2.5 watts	205 source lumens	3000°K	85
	24 VDC constant voltage (LED)				
1.66"  Stainless Steel  Aluminum	120 - 277V Universal voltage (Driver)	3 watts	213 source lumens	3000°K	98
	24 VDC constant voltage (LED)				
1.50"  Stainless Steel					
LR6					
1.50"  Stainless Steel  Aluminum	120 - 277V Universal voltage (Driver)	2.5 watts	205 source lumens	3000°K	85
	24 VDC constant voltage (LED)				



Complies with ASHRAE 90.1-2019 allowance for exterior lighting power.

<https://cole-lighting.squarespace.com/s/ASHRAE-901-2019.pdf>

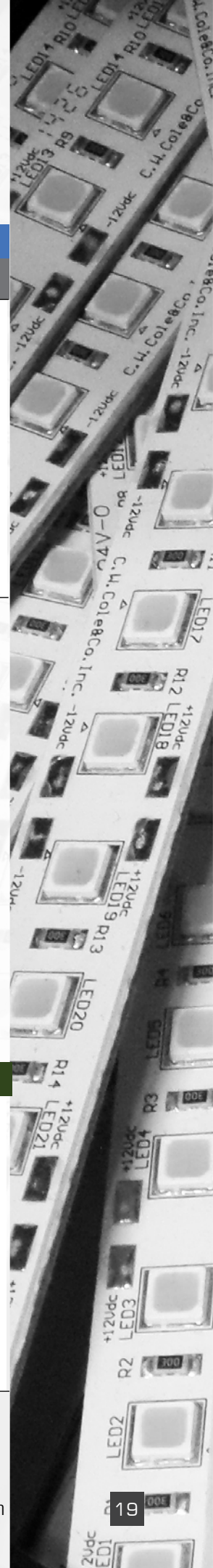

LIGHTRAIL™

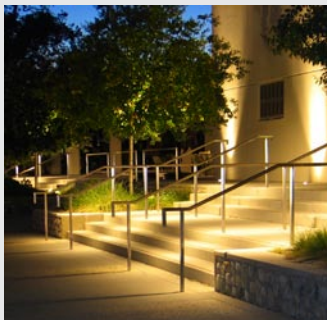

Claremont-McKenna College, Claremont, CA



Denver Art Museum, CO

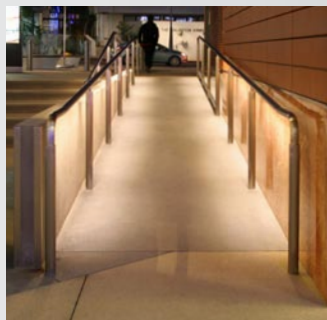

Santa Monica Place, CA

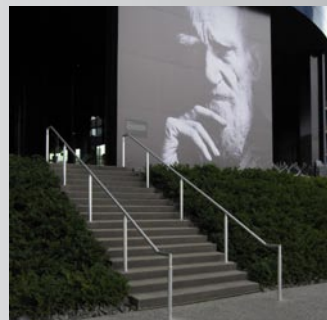

Guthrie Theater, Minneapolis, MN

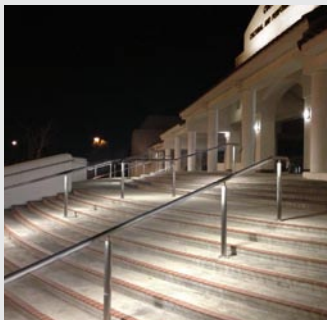

Cuesta College, San Luis Obispo, CA

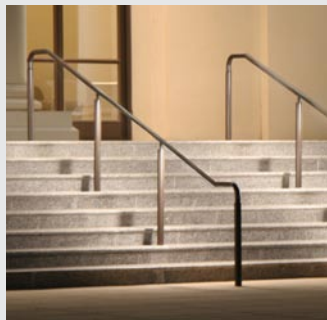

Huntington Library, San Marino, CA

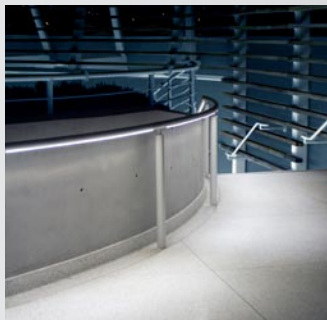

The Frontier Project, Rancho Cucamonga, CA

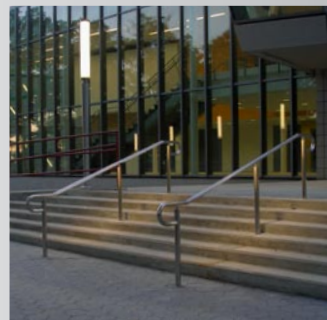

Flushing Meadow, Corona, NY

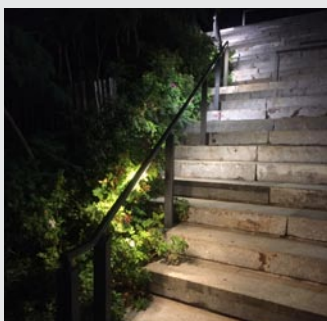

Brooklyn Bridge Park, Brooklyn, NY

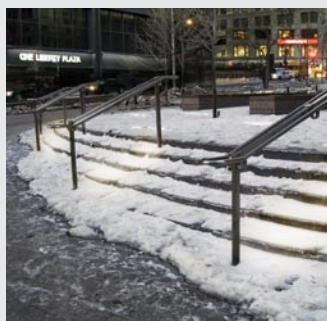

Zucotti Park, New York, NY

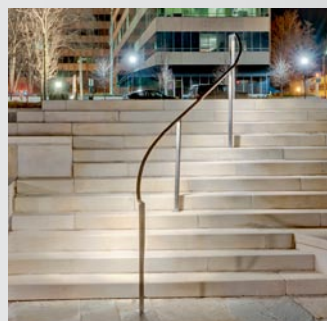

Pack Square Park, Asheville, NC

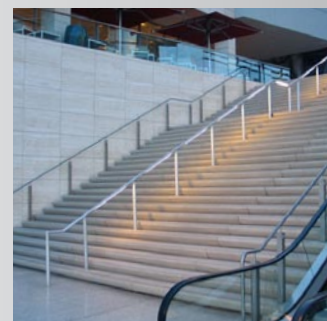

Fashion Show Mall, Las Vegas, NV

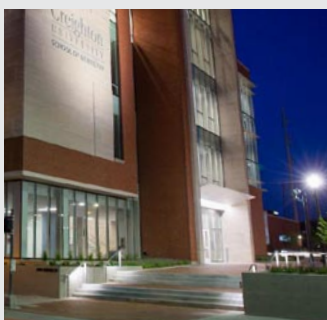

Creighton Univ. School of Dentistry, Omaha, NE



Waukesha Library, WI

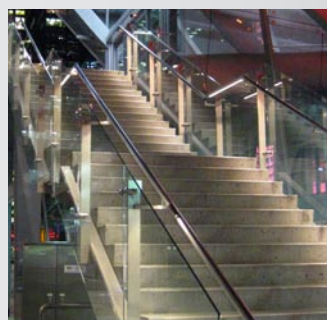

Light Rail Transit, Calgary, AB

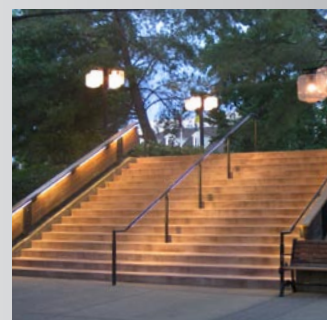

Grand Ole Opry, Nashville, TN

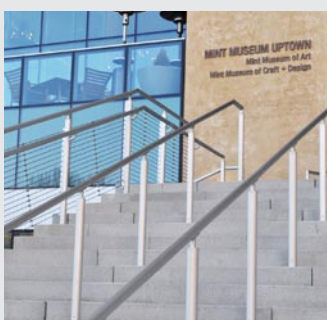

Mint Museum of Art, Charlotte, NC



University of Technology Sydney, AUS

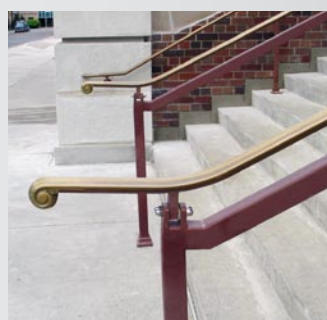

University of Michigan, Ann Arbor, MI

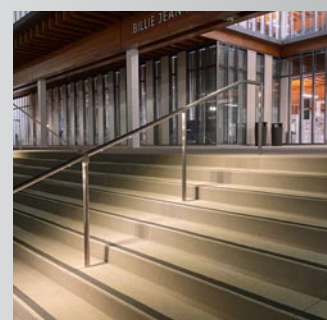

Billie Jean King Main Library, Long Beach, CA

How to Specify

How to Specify

Every Lightrail is custom designed and fabricated to your specific project conditions. Drawings will be submitted on each project requesting specific dimensions to assure proper fit. Plans and elevation drawings are required for pricing and submittal drawing production.

1. Submit catalog number, options, and voltage; (example: LR5P-LED-SS/1.9-INT-RE-277).
2. Add special features and requirements necessary to complete specification.

Series

LR5	LR5 Series 1.9" - 1.66" - 1.5" Dia.
LR6	LR6 Series 1.5" Sq.

Mounting

P	Post Mount
W	Wall Mount

Material

-SS/*	Stainless Steel
-AL/*	Aluminum

* indicate size

Light Distribution

-ASYM	Asymmetric (Not available on LR5) 1.66" and 1.5" diameters
-ASYM/30°	30° tilt

Beam Spread (Clear Lens 90° standard)

-65	65°
-50	50° (Not available on LR5 1.66" and 1.5" diameters)

Power Supply Location

-INT	Integral Driver/Ballast
-REM	Remote Driver/Ballast

End Treatments

-SE	Stub End (LR5 only)
-ME	Miter End
-LE	Loop End
-ELE	Extended Loop End (LR5 only)
-RE	Radius End (LR5 only)
-HE	Hook End (LR6 only)

Color Temperature (3000°K standard)

-4K	4000°K
------------	--------

Other color temperatures available on request

Color LED:

-AMB	590 nm, Amber. FWC Turtle compliant.
-------------	--------------------------------------

Electrical (120V standard)

-277	277V
-DIM	Dimming. Universal voltage 0-10V driver
-EM	Emergency Battery. Provides up to 90 min. operation

Infill

-GLS	Glass*
-MSH	Mesh/Wire*
-CBL	Steel Cable* * Specify design

Options

-BP	Baseplate: Aluminum 5" x 5" x 3/8" Stainless Steel 5" x 5" x 3/16"
-ES	Escutcheon Plates, Round/Square
-FL	Frosted Lens
-SKTB	Skate Deterrent
-U	Unlighted handrail**
-CRV	Curved rail, consult with factory.

** Illuminated rail match



Finishes

Stainless Steel

#4 longitudinal Satin finish, passivated for maximum rust resistance (standard)

-PSS	Polished
-NLS	Non-linear Satin

Aluminum

RAL Powder Coat (standard)

Available Literature:

[RAL Color Chart for Aluminum](#)

[Option ChemFILM® protection for Aluminum](#)

[Passivation Technical Document](#)

[Stainless Steel Cleaning Guide](#)

GUARDRAILS

LR1 LR 1W Wall Mounted LR 1P Post Mounted

The LR1 Series' aluminum extrusion's profile offers excellent asymmetric performance characteristics for both LED and fluorescent sources. A special acrylic prismatic lens optimizes performance across a wide path, such as a pedestrian bridge, while minimizing glare to the eyes.



LR1 rails are available for post and wall mount installations, as well as customized mounting to structures such as existing guard rails. Illumination is provided by a choice of high performance LEDs or T5 fluorescent lamps. Drivers and ballasts are located within the rail, above the light source. The full array of RAL powders are offered, as well as special coatings and anodizing. LR1 is UL/cUL listed, suitable for use in wet locations.

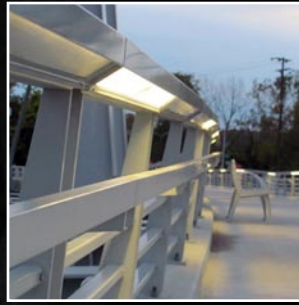

*Main Street Bridge,
Columbus, OH*



*Pedestrian Bridge,
Las Vegas, NV*



LR3 LR 3W Wall Mounted LR 3P Post Mounted

The LR3 Series' 3 1/2" diameter cross-section offers an alternative appearance to the LR1's angular design. Available with both symmetric and asymmetric performance characteristics, LR3 offers significant flexibility. The wrap-around acrylic prismatic lens provides exceptional performance while minimizing glare to the eyes.



LR3 rails are available for post and wall mount installations, as well as customized mounting to most any structure. Illumination is provided by a choice of high performance LEDs or T5 fluorescent lamps. Drivers and ballasts are located within the rail, above the light source. The full array of RAL powders are offered, as well as special coatings and anodizing. LR3 is UL/cUL listed, suitable for use in wet locations.



*Main Place Mall,
Santa Ana, CA*



Warranty

C. W. Cole & Company, Inc., 2560 Rosemead Blvd., South El Monte, CA 91733, warrants to the purchaser that its products will be free from defects in material and workmanship and will be of the designated kind and quality for a period of five (5) years from the date of manufacture by C. W. Cole & Company, Inc. NO IMPLIED STATUTORY WARRANTY OR IMPLIED STATUTORY WARRANTY OF MERCHANTABILITY OR FITNESS FOR PARTICULAR PURPOSE SHALL APPLY BEYOND THE AFOREMENTIONED FIVE (5) YEAR PERIOD. The foregoing warranty is exclusive of all other statutory, written or oral warranties, and no other warranties of any kind, statutory or otherwise, are herein expressed.

Exception: Light Emitting Diode (LED) products are included in this warranty for a period of five years. Drivers will abide by their respective manufactures's warranty.

This warranty is not applicable to any product manufactured by C. W. Cole & Company, Inc. which is not installed and operated in accordance with:

- The National Electrical Code (NEC)
- The Standards for Safety of Underwriters Laboratories, Inc. (UL)
- The standards of the American National Standards Institute (ANSI)
- The specific instructions provided by C. W. Cole & Company, Inc.

If it appears within five (5) years from the date of manufacture by C.W. Cole & Company, Inc. that any product does not meet the warranty specified above, the purchaser must notify C. W. Cole & Company, Inc. of its warranty claim in writing by United States Mail. Within 60 days of receipt, C. W. Cole & Company, Inc. shall correct any defects at C. W. Cole & Company, Inc. expense and at C. W. Cole & Company, Inc. option said correction of defects shall be made either by (1) repairing any defective part or parts by making available a repaired part or product, or (2) replacing any defective part or parts by making available a replacement part or product.

LIMITATIONS OF LIABILITY (a) SELLER WILL NOT UNDER ANY CIRCUMSTANCES, WHETHER AS A RESULT OF BREACH OF CONTRACT, BREACH OF WARRANTY, TORT OR OTHERWISE BE LIABLE FOR CONSEQUENTIAL, INCIDENTAL, SPECIAL OR EXEMPLARY DAMAGES, including, but not limited to, loss of profits, revenues, or capital, cost of substitute products, facilities or services, downtime cost, or claim of Buyer's customers. (b) SELLER'S LIABILITY ON ANY CLAIM OF ANY KIND FOR ANY LOSS OR DAMAGE ARISING OUT OF, RESULTING FROM, OR CONCERNING ANY ASPECT OF THIS AGREEMENT OR FROM THE PRODUCTS OR SERVICES FURNISHED HEREUNDER SHALL NOT EXCEED THE PRICE OF THE SPECIFIC ORDER OR SHIPMENT WHICH GIVES RISE TO THE CLAIM.

Terms and Conditions for Lightrail™

ORDER ACCEPTANCE

Purchasers may consider their orders accepted by COLE unless otherwise notified within two weeks of receipt. COLE reserves the right to select its own customers and to reject any order.

PRICES

All orders are subject to effective prices and terms of sale in effect on date of order entry, unless otherwise authorized and specified in writing by COLE. Quotations are valid for delivery within six months of date of quotation unless otherwise specified.

TAXES

Prices do not include any federal, state, or local taxes.

TERMS OF PAYMENT

A 10% deposit will be required before submittal drawings will become available; additionally, 40% will be required with release of order. Payment balance will be Net 30 to approved credit only. A finance charge of 1½% per month will be assessed on past due invoices. Any account submitted for collection is subject to reasonable attorney fees and costs.

FREIGHT

Transportation costs will be pre-paid and charged to the customer, unless specifically quoted otherwise. Refused shipments are considered the property of the consignee and will be deemed so until credit or reshipment is negotiated. Cost of reshipment will be added the invoice.

CANCELLATIONS

Cancellation charges will be applicable at any time after an order is received by Cole Lighting. The amount of these charges will be determined by Cole, and may include complete forfeiture of any deposits as well as additional charges for work performed at time of cancellation

RETURNS

Return of Lightrail products is not applicable; all orders are custom configured and constructed

Products returned for defects in manufacture or errors in shipments will be accepted at full credit. No products are to be returned without a return authorization (RGA). Authorization will not be given to return goods more than six months following shipment.



COLE
Lighting
...since



Partial List of Installations

Amazon, Seattle - WA
Art Institute of Chicago - IL
Bloomingdale Trail, Chicago - IL
Brampton Performing Arts-Rose Theatre - ON
Bristol Myers Squibb Princeton Pike - NJ
Brooklyn Bridge Park - NY
Claremont-McKenna College - CA
Cleveland Museum of Arts - OH
Denver Art Museum - CO
Disney World Contemporary Resort, Orlando - FL
Dubai International Airport - UAE
Elbow River Pedestrian Bridge, Calgary - AB
Fashion Show Mall, Las Vegas - NV
Franklin County Courthouse, Columbus - OH
Grinnell College Field House/Pool - IA
Guthrie Theater, Minneapolis - MN
Houston Methodist Hospital - TX
Hudson River Park Boathouse - NY
Huntington Library, San Marino - CA
Katy Trail Bridge, Dallas - TX
Manulife, Calgary, Alberta - CAN
Lewis and Clark Caverns, Whitehall - MT
Liberty Park, New York - NY
Light Rail Transit, Calgary, Alberta - CAN
Manulife, Calgary, Alberta - CAN
Metropolitan Museum of Art, New York, NY
Miami (Perez) Art Museum - FL
Mint Museum of Art, Charlotte - NC
Montgomery College, Rockville - MD
National Center for Civil and Human Rights,
Atlanta - GA
National Museum of Natural History -
Smithsonian Institution, Washington - D.C.
Port of LA Headquarters, Los Angeles - CA
Pueblo County Judicial Building - CO
Rutgers University - Business School - NJ
San Francisco-Oakland Bay Bridge Bikeway - CA
Santa Monica Place - CA
Stanford University Meyer Library, Palo Alto - CA
Staten Island Courthouse - NY
Syracuse University Carnegie Library - NY
University of Oregon, Price Science, Eugene - OR
University of KY, Student Center, Lexington - KY
University of Michigan Clements Library,
Ann Arbor, MI
University of Southern California - Galen Center,
Los Angeles, CA
University of Technology Sydney - AUS
Winsor City Hall, Ontario - CAN
WMATA Union Station, Was Washington DC
WTC Cortlandt Way, New York - NY
Yankee Stadium, Bronx - NY
Zucotti Park Plaza, New York, NY

LIGHTRAIL™
Illuminated Handrail

C.W. Cole & Company, Inc.

2560 Rosemead Boulevard
South El Monte, CA 91733-1593
Tel. (626) 443-2473 - Fax (626) 443-9253
www.colelighting.com

